

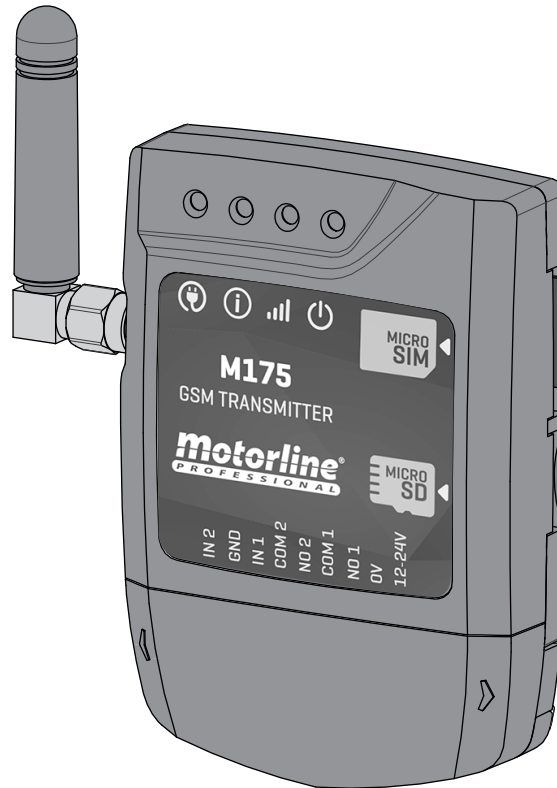

M175

USER'S/INSTALLER'S MANUAL







00. CONTENT

INDEX

01. SAFETY INSTRUCTIONS	2B
02. THE DEVICE	
DEVICE FUNCTIONS	5A
TECHNICAL CHARACTERISTICS	5B
VISUAL ASPECT	6
03. INSTALLATION	
WIRING AND FIXING	7A
CONNECTIONS	7B
04. PRE-CONFIGURATION	
ACCESS PASSWORDS	8A
CONFIGURATION COMMANDS	8A
SETTINGS LEGEND	8B
RESPONSE SMS FORMAT	9A
05. CONFIGURATION THROUGH SMS	
ESSENTIAL CONFIGURATION STEPS	9B
RESTORE SETTINGS	9B
DEVICE NAME	9B
SET UP SIM CARD NUMBER	10A
SET UP ADMINISTRATOR PASSWORD	10A
CONFIGURE CLOCK MANUALLY	10B
RECOVER ADMINISTRATOR PASSWORD	11A
CHECK GSM SIGNAL QUALITY	11A
SET UP BLUETOOTH PAIRING TYPE	11B
PRE-SET HOURS FOR CALLINGS OF USERS	12A
PRE-SET DAYS OF THE WEEK FOR CALLINGS OF USERS	12B
SET USER	13A
ACTIVATE LIMIT TIME CONTROL	14A
CONFIGURE RELAYS	14B
RESTRICT RELAY 1 BY CALL	15B
SET UP CONTACTS FOR FEEDBACK	15B
CHECK ENTRY STATUS 1 AND 2	16B
CHECK LAST CALL	16B
06. USE AS ALARM	
CONFIGURE M175 AS ALARM COMMUNICATOR	17
CONFIGURE THROUGH SMS	17
07. ACCESS RECORD	
REGISTER WITH microSD (OPTIONAL)	18
08. TROUBLESHOOTING	
INSTRUCTIONS FOR FINAL CONSUMERS	19
INSTRUCTIONS FOR SPECIALISED TECHNICIANS	19

01. SAFETY INSTRUCTIONS

ATTENTION:

	This product is certified in accordance with European Community (EC) safety standards.
	This product complies with Directive 2011/65/EU of the European Parliament and of the Council, of 8 June 2011, on the restriction of the use of certain hazardous substances in electrical and electronic equipment.
	(Applicable in countries with recycling systems). This marking on the product or literature indicates that the product and electronic accessories (eg. Charger, USB cable, electronic material, controls, etc.) should not be disposed of as other household waste at the end of its useful life. To avoid possible harm to the environment or human health resulting from the uncontrolled disposal of waste, separate these items from other types of waste and recycle them responsibly to promote the sustainable reuse of material resources. Home users should contact the dealer where they purchased this product or the National Environment Agency for details on where and how they can take these items for environmentally safe recycling. Business users should contact their vendor and check the terms and conditions of the purchase agreement. This product and its electronic accessories should not be mixed with other commercial waste.
	
	This marking indicates that the product and electronic accessories (eg. charger, USB cable, electronic material, controls, etc.) are susceptible to electric shock by direct or indirect contact with electricity. Be cautious when handling the product and observe all safety procedures in this manual.

01. SAFETY INSTRUCTIONS

GENERAL WARNINGS

- This manual contains very important safety and usage information. very important. Read all instructions carefully before beginning the installation/usage procedures and keep this manual in a safe place that it can be consulted whenever necessary.
- This product is intended for use only as described in this manual. Any other enforcement or operation that is not mentioned is expressly prohibited, as it may damage the product and put people at risk causing serious injuries.
- This manual is intended firstly for specialized technicians, and does not invalidate the user's responsibility to read the "User Norms" section in order to ensure the correct functioning of the product.
- The installation and repair of this product may be done by qualified and specialized technicians, to assure every procedure are carried out in accordance with applicable rules and norms. Nonprofessional and inexperienced users are expressly prohibited of taking any action, unless explicitly requested by specialized technicians to do so.
- Installations must be frequently inspected for unbalance and the wear signals of the cables, springs, hinges, wheels, supports and other mechanical assembly parts.
- Do not use the product if it is necessary repair or adjustment is required.
- When performing maintenance, cleaning and replacement of parts, the product must be disconnected from power supply. Also including any operation that requires opening the product cover.
- The use, cleaning and maintenance of this product may be carried out by any persons aged eight years old and over and persons whose physical, sensorial or mental capacities are lower, or by persons without any knowledge of the product, provided that these are supervision and instructions given by persons with experienced in terms of usage of the product in a safe manner and who understands the risks and dangers involved.
- Children shouldn't play with the product or opening devices to avoid

the motorized door or gate from being triggered involuntarily.

WARNINGS FOR TECHNICIANS

- Before beginning the installation procedures, make sure that you have all the devices and materials necessary to complete the installation of the product.
- You should note your Protection Index (IP) and operating temperature to ensure that is suitable for the installation site.
- Provide the manual of the product to the user and let them know how to handle it in an emergency.
- If the automatism is installed on a gate with a pedestrian door, a door locking mechanism must be installed while the gate is in motion.
- Do not install the product "upside down" or supported by elements do not support its weight. If necessary, add brackets at strategic points to ensure the safety of the automatism.
- Do not install the product in explosive site.
- Safety devices must protect the possible crushing, cutting, transport and danger areas of the motorized door or gate.
- Verify that the elements to be automated (gates, door, windows, blinds, etc.) are in perfect function, aligned and level. Also verify if the necessary mechanical stops are in the appropriate places.
- The central must be installed on a safe place of any fluid (rain, moisture, etc.), dust and pests.
- You must route the various electrical cables through protective tubes, to protect them against mechanical exertions, essentially on the power supply cable. Please note that all the cables must enter the central from the bottom.
- If the automatism is to be installed at a height of more than 2,5m from the ground or other level of access, the minimum safety and health requirements for the use of work equipment workers at the work of Directive 2009/104/CE of European Parliament and of the Council of 16 September 2009.
- Attach the permanent label for the manual release as close as possible

01. SAFETY INSTRUCTIONS

to the release mechanism.

- Disconnect means, such as a switch or circuit breaker on the electrical panel, must be provided on the product's fixed power supply leads in accordance with the installation rules.
- If the product to be installed requires power supply of 230Vac or 110Vac, ensure that connection is to an electrical panel with ground connection.
- The product is only powered by low voltage safety with central (only at 24V motors)

WARNINGS FOR USERS

- Keep this manual in a safe place to be consulted whenever necessary.
- If the product has contact with fluids without being prepared, it must immediately disconnect from the power supply to avoid short circuits, and consult a specialized technician.
- Ensure that technician has provided you the product manual and informed you how to handle the product in an emergency.
- If the system requires any repair or modification, unlock the automatism, turn off the power and do not use it until all safety conditions have been met.
- In the event of tripping of circuits breakers or fuse failure, locate the malfunction and solve it before resetting the circuit breaker or replacing the fuse. If the malfunction is not repairable by consult this manual, contact a technician.
- Keep the operation area of the motorized gate free while the gate in in motion, and do not create strength to the gate movement.
- Do not perform any operation on mechanical elements or hinges if the product is in motion.

RESPONSABILITY

- Supplier disclaims any liability if:
 - Product failure or deformation result from improper installation use or maintenance!
 - Safety norms are not followed in the installation, use and maintenance of the product.
 - Instructions in this manual are not followed.
 - Damaged is caused by unauthorized modifications
 - In these cases, the warranty is voided.

SYMBOLS LEGEND:



• Important safety notices



• Useful information



• Programming information



• Potentiometer information



• Connectors information



• Buttons information

02. THE DEVICE

DEVICE FUNCTIONS

- Control of two outputs independently or interconnected.
- Device status monitoring via two inputs.
- Possibility to configure SMS onto send activity feedback up to 4 numbers.
- Configuration through android application (bluetooth) or sms.
- Possibility to switch the outputs between monostable or bistable operation mode.
- User control by limit time.
- Weekly user control.
- Allows to configure up to 509 numbers / users.
- Register, on microSD card (not supplied) of phone calls made in the last 10 days.
- Sms configuration: add and delete users, change administrator or user password, change relay pulse time (max 99 sec), activate and deactivate user control for limit time, synchronize device clock with date and GSM network time.
- Setting by Android application (Bluetooth).
- Application Configuration for iOS available soon. (* Possibility of configuring the m175 with iPhone via SMS.)

02. THE DEVICE

TECHNICAL CHARACTERISTICS

The M175 device has been designed to control remotely equipment (via GSM) via phone call and SMS, or via Bluetooth connection.

• Power Supply	12-32Vdc / 12-24Vac
• Consumption	200mA in stand-by (2A at the time of receiving command)
• Max. Capacity switching	0.5A to 125Vac; 1A to 24Vdc
• Operating Temperature	-20°C ~ +55°C
GSM	
• Frequency	Quad-band 850/900/1800/1900MHz
• Transmission Power	Compatible with GSM phase 2/2 + Class 4 (2W) to GSM 850 and EGSM 900 Class 1 (1W) to DCS 1800 and PCS 1900
• Maximum capacity of numbers / users	509 Contacts
BLUETOOTH	
• Bluetooth version	3.0 + EDR
• Power Class	1.5
• Frequency band	2402 – 2480MHz
• Output power	4dBm
• Communication range	<30m
• Maximum number of simultaneous users	1

02. THE DEVICE

VISUAL ASPECT

🔌 LED POW		
OFF		Without power
ON		With power
ℹ️ LED ACT		
1st pulse sequence	Blinks once	Normal operation
	Blinks 2 times	With active bluetooth user
Pause of 1 second		
2nd pulse sequence	Blinks once	Network signal Excellent
	Blinks 2 times	Network signal Good
	Blinks 3 times	Network signal Weak
	Blinks 4 times	Network signal very weak
ON for 10 sec		GSM starting
Blinks for 10 sec.		GSM turning off
📶 LED NET		
Blinks every 1 sec.		No GSM network
Blinks every 3 secs.		With GSM network
🔌 LED STAT		
OFF		Module is inactive
ON		Module is active and operate

CONNECTORS LEGEND

CONNECTION	DESCRIPTION
I2	Input 2 NO/NC
GND	Common
I1	Input 1 NO/NC
COM2	Common Relay Output 2
NO2	Relay Output 2 NO
COM1	Common Relay Output 1
NO1	Relay Output 1 NO
0V	0V power input
12-24V	Power Input 12-24V AC / DC

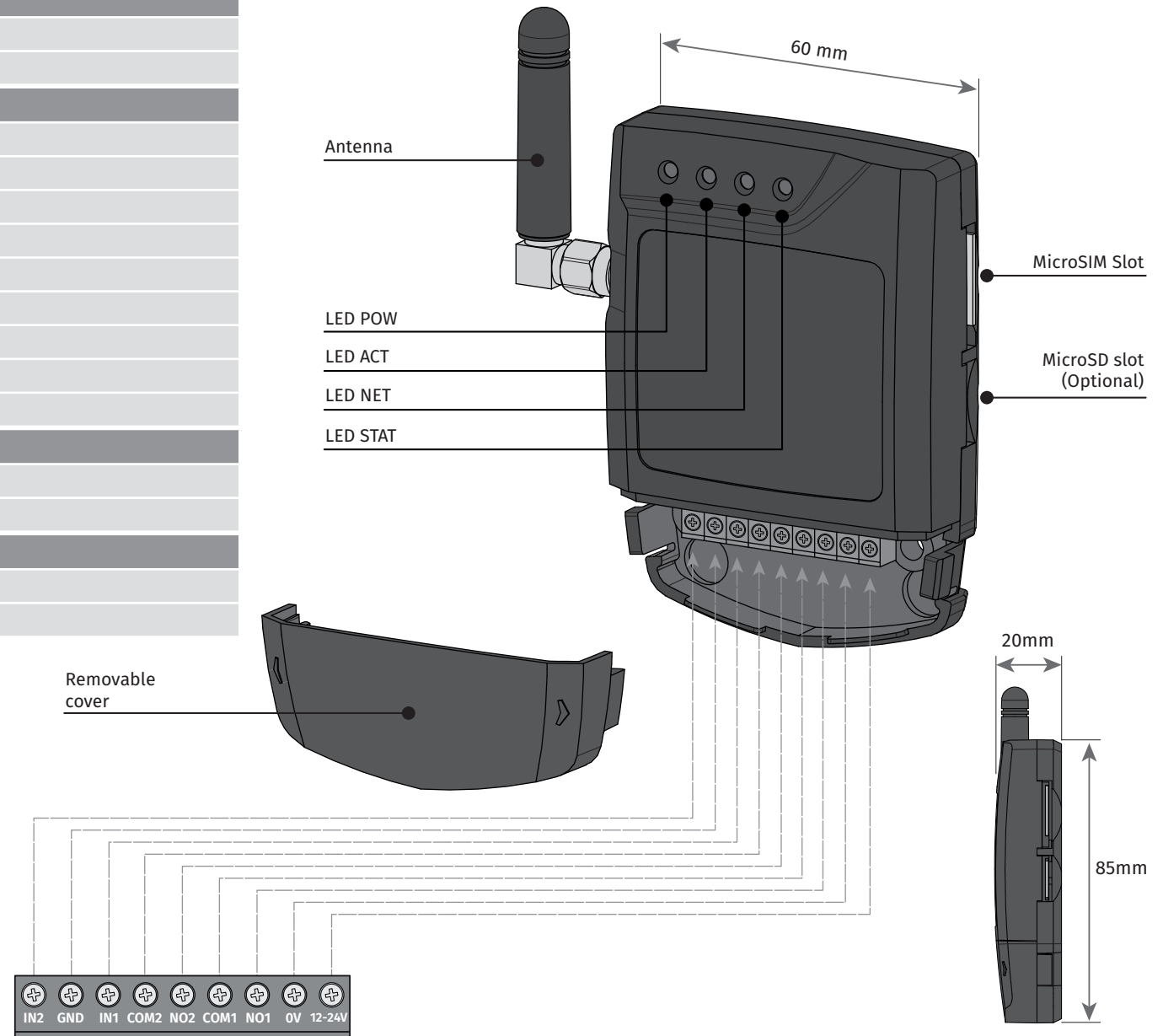

03. INSTALLATION

WIRING AND FIXING

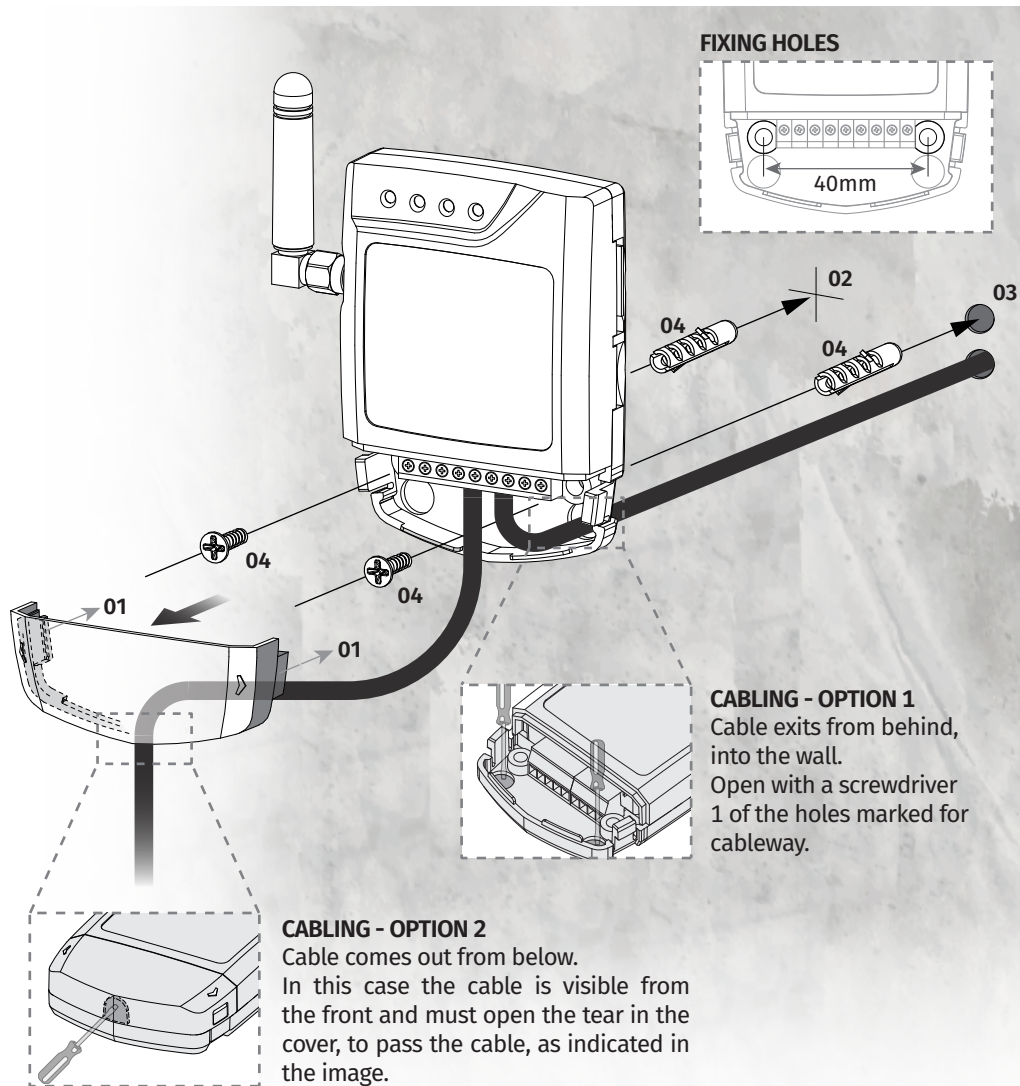

FIXING HOLES

40mm

CABLING - OPTION 1
Cable exits from behind, into the wall.
Open with a screwdriver 1 of the holes marked for cableway.

CABLING - OPTION 2
Cable comes out from below.
In this case the cable is visible from the front and must open the tear in the cover, to pass the cable, as indicated in the image.

FIXATION

- 01 • Remove the cover of the machine by pulling on the side hooks.
- 02 • Mark the 2 fixing holes.
- 03 • Drill the holes.
- 04 • Attach the equipment using appropriate bushings and screws.

03. INSTALLATION

CONNECTIONS

- 01 • Insert the MicroSIM card into the upper slot on the right side.
- NOTE:** MicroSIM can not contain active security PIN!
- 02 • Make the outputs and inputs connections of the device with the desired devices.
- 03 • Connect the device to a power supply, and the POW, ACT and STAT LEDs will light up according to the table on the previous page.
- 04 • When the ACT LED starts blinking and the NET LED indicates the connection to the GSM network, you can start programming the device.

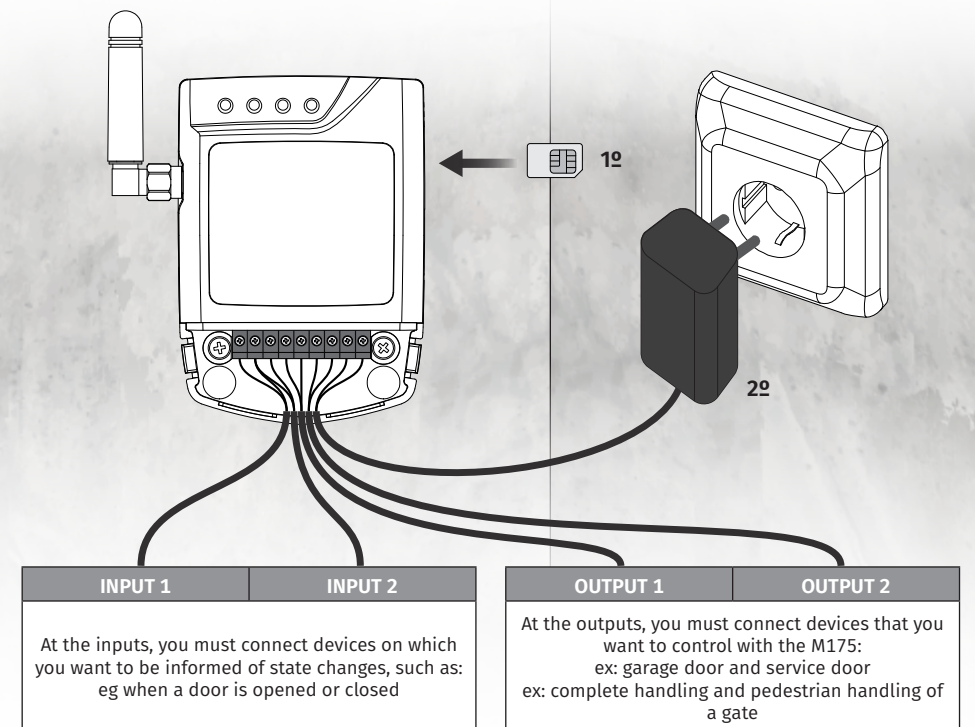

- The device initiation process should last approximately 10 seconds.
- The MicroSIM card used must have a minimum balance available to send 3 messages.
- **To keep the MicroSIM card active, the device automatically sends an SMS to the mobile operator after 2000 hours of usage (approx 3 months).***
*This operation may have costs. For more information, contact your mobile operator.

04. PRE-CONFIGURATION

ACCESS PASSWORDS

Only those who have Administrator password are allowed to make settings on the GSM M175 via SMS / Bluetooth.

- The default administrator password is **9999**.



If you have a user password, you can only activate/desactivate the relays.

CONFIGURATION COMMANDS

To change any function it is necessary to send an **SMS** to the number of the microSIM card in the device, with the characters correspondent to the function to be changed.

- **Between the values, you must add a period (.) Or a space, as shown in the screen below.**
- **The use of uppercase or lowercase characters has no relevance at sending the SMS.**

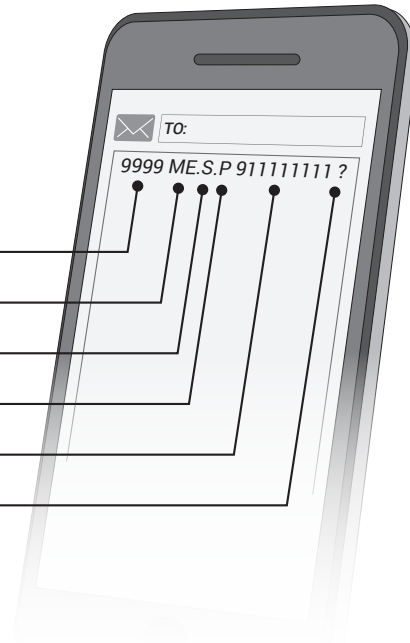

Password (eg: **9999**)

Element (eg: **me**)

Command (eg: **s**)

Parameter (eg: **p**)

Value (eg: **911111111**)

?



To receive a response message from the function that you changed, you can put a **space** and question mark (?) at the end of the outgoing message. In command **G** is not necessary ? because it is a query function (request for information).

04. PRE-CONFIGURATION

SETTINGS LEGEND

ELEMENTS	DESCRIPTION
ME	Setting up general functions
UR	Setting up user roles
R1	Setting up Output 1 functions
R2	Setting up Output 2 functions
I1	Notified event was from Input 1
I2	Notified event was from Input 2
F1	SMS Event 1 Configuration (Feedback 1)
F2	SMS Event 2 Configuration (Feedback 2)
F3	SMS Event 3 Configuration (Feedback 3)
F4	SMS Event 4 Configuration (Feedback 4)

COMMANDS	DESCRIPTION
S	Set / Configure / Add / Activate
G	Get / Check / List / Search
R	Delete / Remove / Disable



Some parameters are only compatible with some of the functions in the **ELEMENTS** table. Check below the **PARAMETERS** table.

PARAMETERS	DESCRIPTION	ME	UR	R1/R2	F1/F2/F3/F4
*	All	✓	✓		
H	Schedule		✓		
W	Days of the week		✓		
M	Mode			✓	
B	Pairing	✓		✓	
T	Time			✓	
P	Phone				✓
F	Feedback				✓
N	Name	✓			

04. PRE-CONFIGURATION

SETTINGS LEGEND

PARAMETERS	DESCRIPTION	ME	UR	R1/R2	F1/F2/F3/F4
Q	Signal	✓			
I	Reset/Input Code	✓			✓
C	Clock	✓			
L	Last	✓			
A	Administrator	✓			
R	Relay			✓	
U	User		✓		

RESPONSE SMS FORMAT

The M175 makes it possible to return an SMS indicating the result of the operation you have performed. The return message is displayed as follows.

• **Example:** Respond to a change of the administrator password.

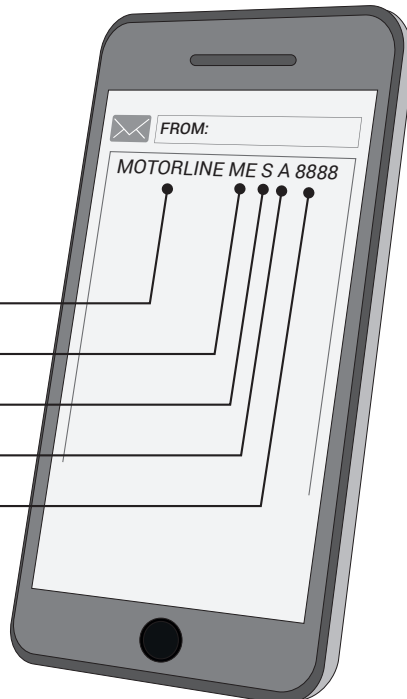

Device Name (eg: **MOTORLINE**)

Element (eg: **me**)

Command (eg: **s**)

Parameter (eg: **a**)

Value (eg: **8888**)

05. CONFIGURATION THROUGH SMS

ESSENTIAL CONFIGURATION STEPS

To start using the M175 correctly, you must configure some important fields. *Follow these steps to complete this setup:*

01 • Add a user to the device (page 13A)

02 • Set up the number of the SIM card inserted in the device. *Wait about 1 minute for the M175 to set the date and time.*

03 • Check up of the date and time values are updated. If they are wrong, set the clock manually (see page 10B).

04 • Set a new Administrator password (see page 11A).

05 • Try activate Relay 1 via SMS as an administrator (see page 14B).

06 • Try activate Relay 2 via SMS as an administrator (see page 14B).

07 • Ask the user configured to 01 to use his phone to activate the relay 1 via SMS as a user (see page 14B). *Repeat this step for Relay 2.*

08 • Ask the user configured to 01 to use his phone to activate Relay 1 by Call.

RESTORE SETTINGS



This menu allows to restore the initial settings except: The Administrator Password and Added Users.

Function	Send Message	Device Response
Restore Settings	9999 ME.R.* ?	MOTORLINE ME R * 0
<i>(in this function you should put "?" at the end of the sent message if you want to receive a reply)</i>		

DEVICE NAME



Each M175 is identified by a name that can be up to 15 characters long.

Factory setting: MOTORLINE

Function	Send Message	Device Response
Check Name	9999 ME.G.N	MOTORLINE ME G N MOTORLINE
Set Name	9999 ME.S.N MOTORLINE2 ?	MOTORLINE ME S N MOTORLINE2
Restore Name	9999 ME.R.N ?	MOTORLINE ME R N MOTORLINE
<i>(in these functions you should put "?" at the end of the message you send if you want to receive a reply)</i>		

05. CONFIGURATION THROUGH SMS

SET UP SIM CARD NUMBER



You must configure the device with the number corresponding to the SIM card inserted. This setting allows automatic synchronization of the date and time.

• **This allows the M175 to send a message every 3 months so that the mobile operator does not disable the card and send a message in case of restarting the M175 to synchronize the clock with the GSM network date and time.**

Factory setting: 0 (without number)

Function	Send Message	Device Response
Check Number	9999 ME.G.P	MOTORLINE ME G P 91XXXXXX
Set Number	9999 ME.S.P 91XXXXXX ?	MOTORLINE ME S P 91XXXXXX
Restore Number	9999 ME.R.P ?	MOTORLINE ME R P 0

(in these functions you should put "?" at the end of the message you send if you want to receive a reply)

SET UP ADMINISTRATOR PASSWORD



The Administrator password allows you to perform all the settings and perform all operations.

Factory setting: 9999

Function	Send Message	Device Response
Check Password	9999 ME.G.A	MOTORLINE ME G A 9999
Set Password	9999 ME.S.A XXXX ?	MOTORLINE ME S A XXXX

(in this function you should put "?" at the end of the sent message if you want to receive a reply)



If the user loses the administrator password, he can recover the password by default through the steps indicated in the **RECOVER ADMINISTRATOR PASSWORD** menu (see page 11A).

05. CONFIGURATION THROUGH SMS

CONFIGURE CLOCK MANUALLY



For proper operation of all device time functions, the date and time of the clock must be correct.

This update can be done manually with the instructions in this menu, or automatically when the **CONFIGURE SIM CARD NUMBER** menu is set (see page 10A). The insertion value of the date and time is **yy.mm.dd.hh.mm.ss.zz**.

Factory setting: 04/01/01,00:00:00+00

Year (eg: yy)

Month (eg: mm)

Day (eg: dd)

Hours (eg: hh)

Minutes (eg: mm)

Seconds (eg: ss)

GMT (eg: zz) *Optional

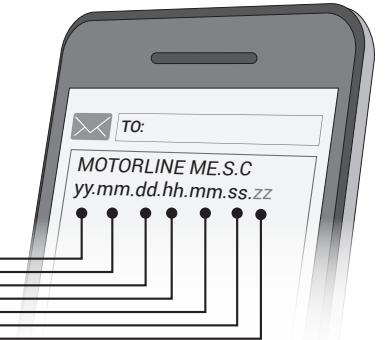

Function	Send Message	Device Response
Check Clock	9999 ME.G.C	MOTORLINE ME S C 04/01/01,00:00:00+00
Set Clock	9999 ME.S.C 19.04.30.12.30.00.00 ?	MOTORLINE ME S C 19/04/30,12:30:00+00

(in this function you should put "?" at the end of the sent message if you want to receive a reply)

05. CONFIGURATION THROUGH SMS

RECOVER ADMINISTRATOR PASSWORD



Each M175 has a code (15 digits) that allows to reset the Administrator password in case of oversight.

You can obtain this code through the "Check RESET Code" step, or contact MOTORLINE indicating the IMEI that is printed on the GSM module on the PCB.

Function	Send Message	Device Response
Check RESET Code	9999 ME.G.I	MOTORLINE ME G I XXXXXXXXXXXXXXXX
Reset Password	M175 ME.R.A XXXXXXXXXXXXXXXX	MOTORLINE ME R A XXXXXXXXXXXXXXXX

(in this function you should put "?" at the end of the sent message if you want to receive a reply)



You should store this code in a safe place in case you need it.

CHECK GSM SIGNAL QUALITY



You can check GSM signal quality received by the device. The value sent by GSM is RSSI (see table for matching).

Function	Send Message	Device Response
Check GSM Signal	9999 ME.G.Q	MOTORLINE ME G Q 25

SIGNAL CORRESPONDENCE TABLE

RSSI	dBm	Signal
2 a 9	-109 a -95	Marginal
10 a 14	-93 a -85	OK
15 a 19	-83 a -75	Bom
20 a 30	-73 a -53	Excelente

05. CONFIGURATION THROUGH SMS

SET UP BLUETOOTH PAIRING TYPE



Two Bluetooth pairing modes are available with the device.

- **Permanent mode (0):** GSM stores up to 10 paired Bluetooth devices, not allowing the pairing of any other devices. For a new pairing, you'll need to delete all previously paired devices. To do so, switch to Temporary Mode and disconnect from the M175, so that all pairings are cleared.
- **Temporary mode (1):** GSM does not memorize any Bluetooth device, and at the end of usage the device will be unpaired. This mode requires pairing in each use, so there is no maximum limit on paired devices.

Factory setting: Permanent Mode (0)

VALUE	DESCRIPTION
0	PERMANENT Bluetooth pairing
1	TEMPORARY Bluetooth Pairing

Function	Message to Send	Device Response
Check Type of Pairing	9999 ME.G.B	MOTORLINE ME G B 0
Set Temporary Pairing	9999 ME.S.B ?	MOTORLINE ME S B 1
Reset Permanent Pairing	9999 ME.R.B ?	MOTORLINE ME R B 0

(in these functions you should put "?" at the end of the message you send if you want to receive a reply)

05. CONFIGURATION THROUGH SMS

PRE-SET HOURS FOR CALLINGS OF USERS



Is possible set a time that is automatically applied to users who are added. This setting defines the daily interval of time that the user is authorized to make calls to the M175.

Factory setting: 000023590



Function	Send Message	Device Response
Check User Hours	9999 UR.G.H	MOTORLINE UR G B 00002359
Set User Hours	9999 UR.S.H 00001230 ?	MOTORLINE UR S H 00001230
Reset User Hours	9999 UR.R.H ?	MOTORLINE UR R H 00002359

(in these functions you should put "?" at the end of the message you send if you want to receive a reply)



The values set in this menu are applied to any user who is added **without specific times**.

- This control applies to users attempting to access via Phone Call, Bluetooth or SMS. It does not apply to the Administrator if it is accessed by Bluetooth or SMS.

05. CONFIGURATION THROUGH SMS

PRE-SET DAYS OF THE WEEK FOR CALLINGS OF USERS



Is possible set the days of the week that users can or cannot activate relay output 1. This configuration value has 7 digits and each corresponds to a day of the week (from Sunday).

0: Day without permission

1: Day with permission

Factory setting: 1111111

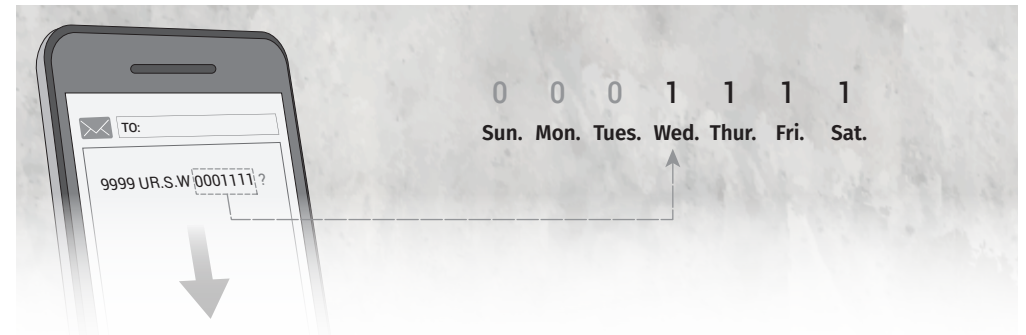

Function	Send Message	Device Response
Check Days of the Week	9999 UR.G.W	MOTORLINE UR G W 1111111
Set Days of the Week	9999 UR.S.W 0001111 ?	MOTORLINE UR S W 0001111
Reset Days of the Week	9999 UR.R.W ?	MOTORLINE UR R W 1111111

(in these functions you should put "?" at the end of the message you send if you want to receive a reply)



The values set in this menu are applied to any user who is added **without specific Days of the Week**.

- This control applies to users attempting to access via Phone Call, Bluetooth or SMS. It does not apply to the Administrator if it is accessed by Bluetooth or SMS.

05. CONFIGURATION THROUGH SMS

SET UP USER



The M175 allows you to add users for activation of Relay 1 or Relay 2. After the user is added, it is only necessary to make a phone Call so that Relay 1 is activated. You can also activate relay 1 or 2 by sending an sms or a Bluetooth command via the App.

NOTE: You can add users with specific Times, Access Days, Password, and Temporary Access. To do this you need to add the values of **Time, Days of the Week, Password** and **Temporary Access** after the value of the phone number:

Example: 9999 ur.s.u.91XXXXXXXX.00001230.111000.0000.30

Function	Send Message	Device Response
Check User	9999 UR.G.U 91XXXXXXXX	MOTORLINE UR G U 91XXXXXXXX.00002359.1111111
Check All Users	9999 UR.G.*	MOTORLINE UR G U 91XXXXXXXX.00002359.1111111

We do not recommend running this operation via SMS, and depending on the number of users in memory, it may take some time and costs. You can use the M175 mobile application, available on Play Store.

Add User	9999 UR.S.U 91XXXXXXXX. 00001230.0001111.0000 ?	MOTORLINE UR S U 91XXXXXXXX. 00001230.0001111 .0000
Add multiple users	9999 UR.S.U 91XXXXXXXX 92XXXXXXXX 93XXXXXXXX 94XXXXXXXX ?	MOTORLINE UR S U 91XXXXXXXX. 00001230.0001111.0000
Delete User	9999 UR.R.U 91XXXXXXXX ?	MOTORLINE UR R U 0
Delete all Users	9999 UR.R.* ?	MOTORLINE UR R U 0

(in these functions you should put "?" at the end of the message you send if you want to receive a reply)



- SMS's cannot exceed the maximum limit of **126 characters**.
- The maximum number of users added per SMS is **8**.

CHANGE VALUES INDIVIDUALLY

Function	Send Message	Device Response
Change Password	9999 UR.S.U 91XXXXXXXX.0000 ?	MOTORLINE UR S U 91XXXXXXXX.00001230.0001111 .0000
Change Time	9999 UR.S.U 91XXXXXXXX.00001230 ?	MOTORLINE UR S U 91XXXXXXXX.00001230.0001111 .0000
Change Days of the Week	9999 UR.S.U 91XXXXXXXX.0001111 ?	MOTORLINE UR S U 91XXXXXXXX.00001230.0001111 .0000

(in these functions you should put "?" at the end of the message you send if you want to receive a reply)

05. CONFIGURATION THROUGH SMS

SET UP USER

The M175 detects whether the value to be changed is **Time, Days of the Week** or **Password** by the number of digits of the value entered in SMS:

- **Time:** 8 digits (Ex: 00001230)
- **Days of the Week:** 7 digits (Ex: 1110000)
- **Password:** 4 digits (Ex: 0000)

NOTE: If a user is configured with none of these values (Example: 9999 ur.s.u 91XXXXXXXX), the M175 defaults the following values:

- **Time:** The value is set in the **PRE-SET HOURS FOR CALLINGS OF USERS**.
- **Days of the Week:** The value is set in the **PRE-SET DAYS OF THE WEEK FOR CALLINGS OF USERS**.
- **Password:** The last 4 digits of the user number are taken on (Example: Number of User 91XXX1234 | Password: 1234).

SET USER WITH TEMPORARY ACCESS

You can add a user with Temporary Access time. This time can diverge between **0** and **99** days. At the end of the days defined in this function, the user is automatically removed from the M175 memory.

If the Temporary Access value is not added, the user is permanently stored.

When checking the User it can take two forms depending on whether the User has Temporary Access or not:

Function	Send Message	Device Response
Check User (with temporary access)	9999 UR.G.U 91XXXXXXXX	MOTORLINE UR G U 91XXXXXXXX.00002359.1111111.20 (this value decreases as the days progress)
Check User (with permanent access)	9999 UR.G.U 91XXXXXXXX	MOTORLINE UR G U 91XXXXXXXX.00002359.1111111.-1

Set Temporary Access	9999 UR.S.U 91XXXXXXXX.30?	MOTORLINE UR S U 91XXXXXXXX.00001230.0001111 .0000.30
----------------------	----------------------------	---

(in this function you should put "?" at the end of the sent message if you want to receive a reply)



In order for the Time and Days of the Week values set in this menu to be applied, you must activate the functions of the menu **ACTIVATE LIMIT TIME CONTROL** (see page 14A).

05. CONFIGURATION THROUGH SMS

ACTIVATE LIMIT TIME CONTROL



You can control user access through limit time. When the menu is active (value 1), the device checks the Time and Days of the Week values for each user in the previous menu.

Factory setting: (0) Disabled

VALUE	DESCRIPTION
0	There is no control of time and days of the week
1	There is control of time and days of the week

Function	Send Message	Device Response
Check Limit Time	9999 UR.G.L	MOTORLINE UR G L 0

Enable Limit Time	9999 UR.S.L ?	MOTORLINE UR S L 1
Disable Limit Time	9999 UR.R.L ?	MOTORLINE UR R L 0

(in these functions you should put "?" at the end of the message you send if you want to receive a reply)

CONFIGURE RELAYS



The M175 has two relay outputs with normally open contact (NO). **Relay Output 1** and **Relay Output 2**.

Relay 1 can be activated by phone call / Bluetooth and SMS.
Relay 2 can only be activated by Bluetooth and SMS.

The activation state of the Relay is given by the values **0** and **1**.

VALUE	DESCRIPTION
0	Relay (s) OFF
1	Relay (s) ON

05. CONFIGURATION THROUGH SMS

CONFIGURE RELAYS

SET UP RELAYS AS AN ADMINISTRATOR

Function	Send Message	Device Response
Check RELAY status 1	9999 R1.G.R	MOTORLINE R1 G R (0/1)
Check RELAY status 2	9999 R2.G.R	MOTORLINE R2 G R (0/1)

Start RELAY 1	9999 R1.S.R ?	MOTORLINE R1 S R 1
Start RELAY 2	9999 R2.S.R ?	MOTORLINE R2 S R 1
Turn off RELAY 1	9999 R1.R.R ?	MOTORLINE R1 S R 0
Turn off RELAY 2	9999 R2.R.R ?	MOTORLINE R2 S R 0

(in these functions you should put "?" at the end of the message you send if you want to receive a reply)

SET UP RELAYS AS A USER

The User is authorized to Check the Relay states but cannot configure their Modes and Impulse Times.

For the User to be able to configure the Relays you must add, in the SMS command to type, your User password (example: 1234) as well as your **user number** (example: 91XXXXXXX).

Function	Send Message	Device Response
Check RELAY status 1	1234 R1.G.R 91xxxxxxx ?	MOTORLINE R1 G R (0/1)
Check RELAY status 2	1234 R2.G.R 91XXXXXXX ?	MOTORLINE R2 G R (0/1)

Start RELAY 1	1234 R1.S.R 91XXXXXXX ?	MOTORLINE R1 S R 1
Start RELAY 2	1234 R2.S.R 91XXXXXXX ?	MOTORLINE R2 S R 1
Turn off RELAY 1	1234 R1.R.R 91XXXXXXX ?	MOTORLINE R1 S R 0
Turn off RELAY 2	1234 R2.R.R 91XXXXXXX ?	MOTORLINE R2 S R 0

(in these functions you should put "?" at the end of the message you send if you want to receive a reply)

05. CONFIGURATION THROUGH SMS

CONFIGURE RELAYS

RELAY MODE

The Relays can operate in two different ways: Monostable and Bistable.

Monostable Mode: The device turns off at the end of the Set Pulse Time if there is no contact.

Bistable Mode: The device remains on / off until a new command is available.

VALUE	DESCRIPTION
0	Monostable Mode
1	Biestable Mode

Function	Send Message	Device Response
Check Relay Mode	9999 R1.G.M	MOTORLINE R1 G M 0

Enable Bistable Mode	9999 R1.S.M ?	MOTORLINE R1 S M 1
Reset Monostable Mode	9999 R1.R.M ?	MOTORLINE R1 R M 0

(in these functions you should put "?" at the end of the message you send if you want to receive a reply)

IMPULSE TIME

The impulse time of the relays can be set and has a range of values from a minimum of **1 second** to a maximum of **240 seconds**.

The default impulse time is **1 second**.

Function	Send Message	Device Response
Check Impulse Time	9999 R1.G.T	MOTORLINE R1 G T 1

Enable Impulse Time	9999 R1.S.T 120 ?	MOTORLINE R1 S T 120
Disable Impulse Time	9999 R1.R.T ?	MOTORLINE R1 R T 1

(in these functions you should put "?" at the end of the message you send if you want to receive a reply)



NOTE: The **Relay Mode** and **Impulse Time** settings are done in the same way for both Relay outputs. You only have to toggle the command between **R1** (Relay1) and **R2** (Relay2) depending on the output you want to configure.

05. CONFIGURATION THROUGH SMS

RESTRICT RELAY 1 BY CALL



There is the possibility of set Relay 1 to be commanded by **Call** only. The configuration values for this function are:

0: Relay Control by Call, Bluetooth and SMS.

1: Relay control by Call only.

Factory setting: (0) Call, SMS & Bluetooth

Function	Send Message	Device Response
See Relay Commands	9999 R1.G.B	MOTORLINE R1 G B 0
Enable Restriction	9999 R1.S.B ?	MOTORLINE R1 S B 1
Disable Restriction	9999 R1.R.B ?	MOTORLINE R1 R B 0

(in these functions you should put "?" at the end of the message you send if you want to receive a reply)

CONFIGURE CONTACTS FOR FEEDBACK



The M175 allows you to set up to four phone contacts so that feedback notifications (SMS) can be sent on unrequest events.

Function	Send Message	Device Response
Check Contact for Feedback	9999 F1.G.P	MOTORLINE F1 G P (0/91XXXXXX)
Set contact for Feedback	9999 F2.S.P 92XXXXXX ?	MOTORLINE F2 S P 92XXXXXX
Delete contact for Feedback	9999 F3.R.P ?	MOTORLINE F3 R P 0

(in these functions you should put "?" at the end of the message you send if you want to receive a reply)

FEEDBACK NOTIFICATIONS

The following table shows the values to enable feedback notifications.

By default the notification value for all contacts is 000000 (no notification type is active).

05. CONFIGURATION THROUGH SMS

SET UP CONTACTS FOR FEEDBACK

	DESCRIPTION	SEND SMS		TEXT OF SMS SENT
		NO	YES	
I1(NO)	The Input1 changes the status from closed to open	0	1	MOTORLINE IN1 OPEN
I1(NC)	The Input1 changes the status from open to closed	0	1	MOTORLINE IN1 CLOSE
I2(NO)	The Input2 changes the status from closed to open	0	1	MOTORLINE IN2 OPEN
I2(NC)	The Input2 changes the status from open to closed	0	1	MOTORLINE IN2 CLOSE
R1	Relay 1 is activated	0	1	MOTORLINE OUT1 ON
R2	Relay 2 is activated	0	1	MOTORLINE OUT2 ON

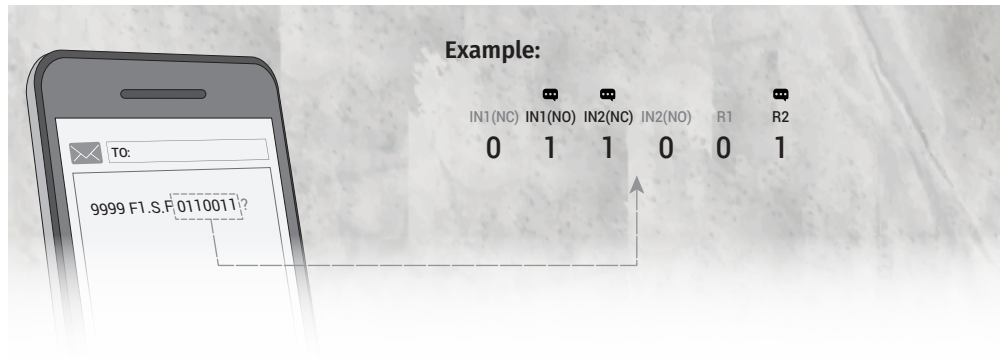

Function	Send Message	Device Response
Check Feedback notifications	9999 F1.G.F	MOTORLINE F1 G F 000000
Set Feedback Notifications	9999 F1.S.F 011001 ?	MOTORLINE F1 S F 011001
Reset feedback notifications	9999 F1.R.F ?	MOTORLINE F1 R F 000000

(in these functions you should put "?" at the end of the message you send if you want to receive a reply)

05. CONFIGURATION THROUGH SMS

CHECK ENTRY STATUS 1 AND 2



It is possible to check the status of device inputs.
The input status of the device is given by the values **0** and **1**.

VALUE	STATE
0	Entry open
1	Entry closed

Function	Send Message	Device Response
Check status of ENTRY 1	9999 I1.G.I	MOTORLINE I1 G I (0/1)
Check status of ENTRY 2	9999 I2.G.I	MOTORLINE I2 G I (0/1)

CHECK LAST CALL



It is possible to verify the last number who called for the M175.

Function	Send Message	Device Response
Check Last Calls	9999 ME.G.L	MOTORLINE ME G L 91XXXXXX

06. USE AS ALARM

CONFIGURE M175 AS ALARM COMMUNICATOR

It is possible to configure the M175 to function as an alarm communicator. When activated, it makes a call to the configured numbers (max. 4).

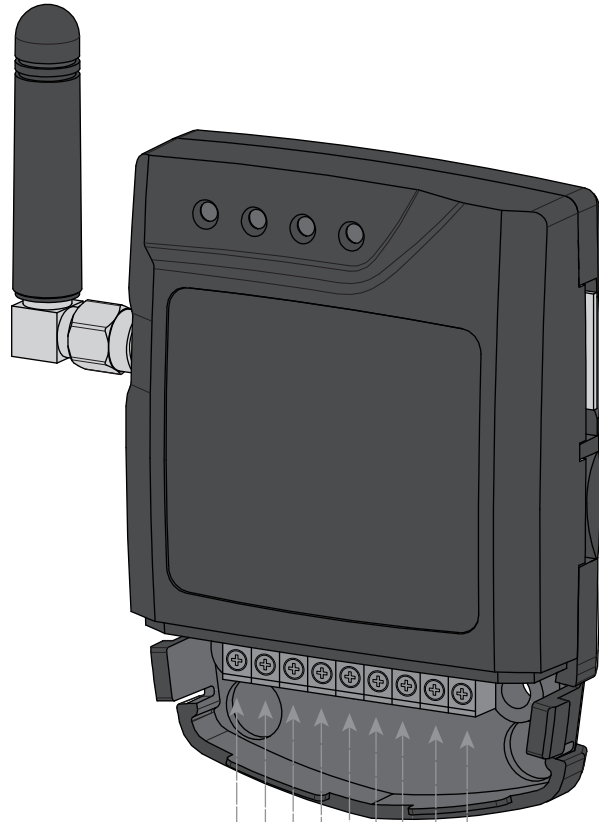

- Make a bridge (Shunt) between IN1 and IN2.



- Connect the alarm output between IN1 and GND.

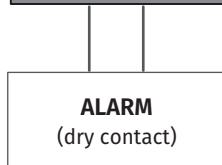

06. USE AS ALARM

CONFIGURE THROUGH SMS

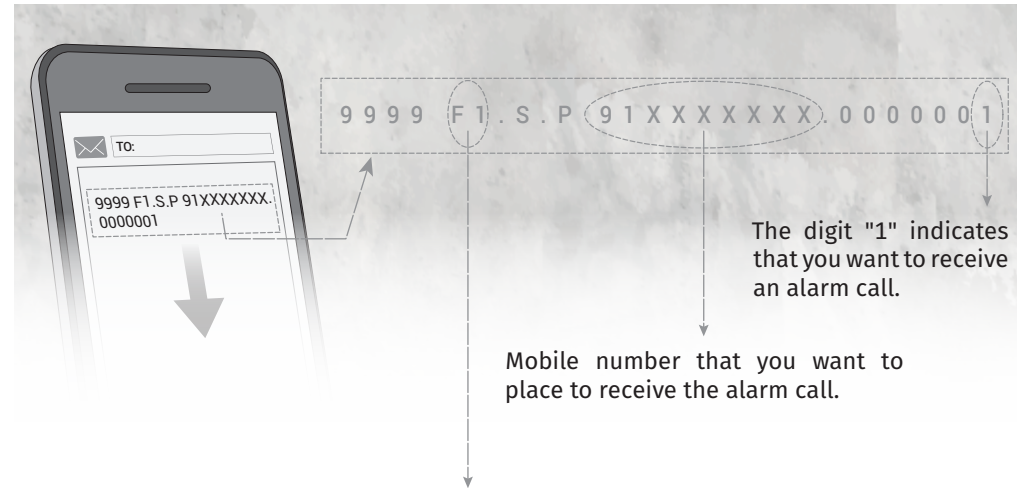

The digit "1" indicates that you want to receive an alarm call.

Mobile number that you want to place to receive the alarm call.

Whenever you add a mobile phone number, change this value in ascending order (**maximum of 4 numbers**):

- 9999 **F1**.S.P 91xxxxxxx.0000001
- 9999 **F2**.S.P 92xxxxxxx.0000001
- 9999 **F3**.S.P 96xxxxxxx.0000001
- 9999 **F4**.S.P 93xxxxxxx.0000001



To turn off the alarm, any 1 of the 4 configured numbers, just need to reject the call.

07. ACCESS RECORD

REGISTER WITH microSD (OPTIONAL)

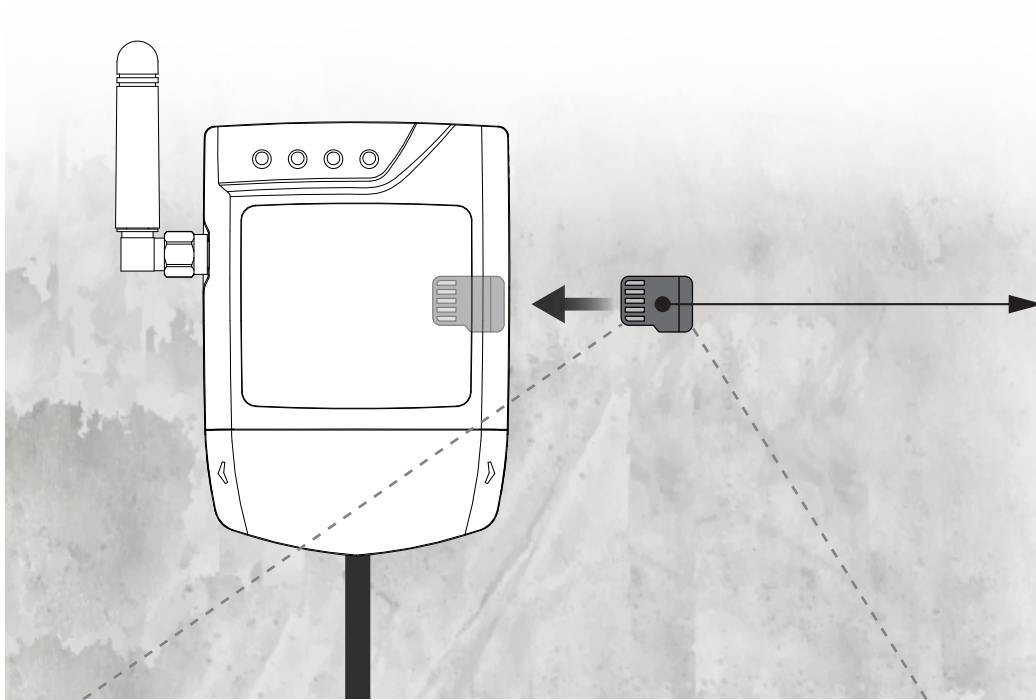

```

1 964685641BT R1 "19/04/29,09:49:43+00"
1 964685641BT R2 "19/04/29,09:49:46+00"
1 +44964685641 R1 "19/04/29,09:50:58+00"
0 +44964685641 R2 "19/04/29,09:51:12+00"
1 964685641 R1 "19/04/29,09:51:23+00"
-1 964685641 UR "19/04/29,10:08:57+00"
-0 964685641 UR "19/04/29,10:09:13+00"
-1 964685641 UR "19/04/29,10:09:31+00"
1 964685641 R1 "19/04/29,10:10:35+00"
    
```

Sheet "access.txt"



It is possible to register for the last 180 days with all accesses that have been made to the device. Whether they are made by **phone calls, Bluetooth or SMS**.

ACCESS RECORD

- 01** • The microSD card automatically generates a text file (access.txt) with a record of all access for the **last 180 days**.
 - 02** • At the end of 180 days the access.txt file is renamed to accessold.txt and a new file (access.txt) is created which will record the next 180 days.
 - 03** • After the 2nd 180-day period, the access.txt file is renamed to accessold.txt and the previous one is deleted.
- The microSD will never store more than 2 files at a time.**

FILE LEGEND "ACCESS.TXT"

COLUMN 1	RESULT OF THE OPERATION
1	Relay was activated (operation succeeded)
0	Relay was deactivated (operation succeeded)
-1	User non-existent or without permission (operation failed)
COLUMN 2	USER INFO
91XXXXXXX	User by Phone Call
+4491XXXXXXX	User by SMS
91XXXXXXXBT	User by bluetooth
COLUMN 3	RELAY INFO
R1	Relay 1
R2	Relay 2
RU	Operation failed
COLUMN4	DATE AND TIME
"00/00/00,00:00:00+00"	Relay 1



To enable this feature, insert a microSD card into the corresponding slot on the M175.

08. TROUBLESHOOTING

INSTRUCTIONS FOR FINAL CONSUMERS

INSTRUCTIONS FOR SPECIALISED TECHNICIANS

Anomaly	Procedure	Behavior	Discovering the origin of the problem
I added a number but I can not activate the GSM output via phone call.	Connect through the bluetooth application to the device and list the users. Check if the number is listed and appears exactly as you entered.	It does not appear in the list.	Try to add the number again. Check if: <ol style="list-style-type: none"> 1 • The number consists only of digits (without any space or other character). 2 • The phone number does not exceed 15 digits. 3 • The password is correct. 4 • The option parameter symbol is the correct one. 5 • You did not enter two spaces instead of one.
		The number appears in the list and is as entered.	<ol style="list-style-type: none"> 1 • Make the phone call again. 2 • Check the number that made the last call. 3 • Compare this number with that added to the device.
I can not connect through the bluetooth application.	<ol style="list-style-type: none"> 1 • Check how often the ACT LED flashes. 	Blinks 5 or 7 times.	<ol style="list-style-type: none"> 1 • There is an active Bluetooth connection on the device. 2 • Ensure that no other user is performing operations on the device. 3 • If no one else is connected, wait 30 seconds for it to be automatically turned off.
		Blinks 1 or 3 times.	<ol style="list-style-type: none"> 1 • Make sure you can find the device by searching for devices in the bluetooth application. 2 • Check the strength of the bluetooth signal from where you are trying to connect through in-app search. 3 • Check if the distance to the device is within range and that there are no environmental barriers (eg walls) that could degrade communication with the device.
The control by time limit is not as defined schedule.	<ol style="list-style-type: none"> 1 • Connect via bluetooth and check the date and time set on the device. 2 • Set the time and date in case of an error. 3 • Turn off the power. 4 • Turn the power back on. 5 • Test the limit control. 	If you restart the device (power off and on again) the time limit control stops working.	<ol style="list-style-type: none"> 1 • Check your SIM card balance.